

	127/230 VAC	230/400 VAC
35A	31616117001NE	31616118801NE
63A	31616117101NE	31616118901NE
80A	31616117201NE	31616119001NE
100A	31616117301NE	31616119101NE
125A	31616117401NE	31616119201NE
160A	31616117501NE	31616119301NE

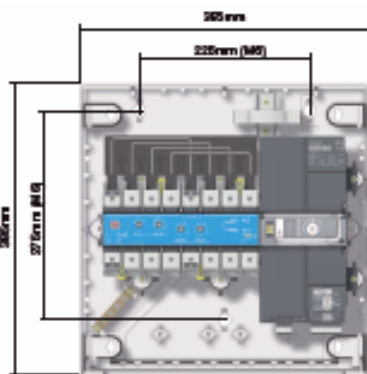

M6

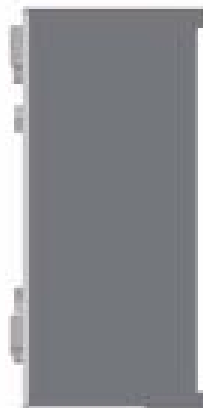
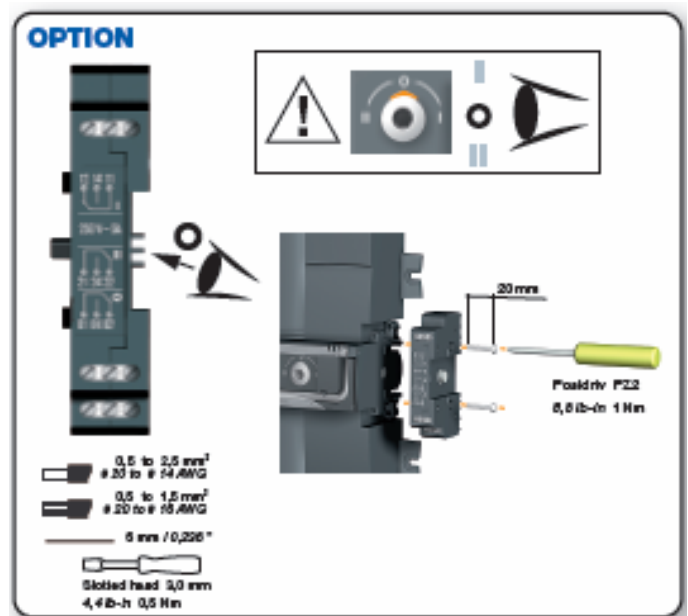
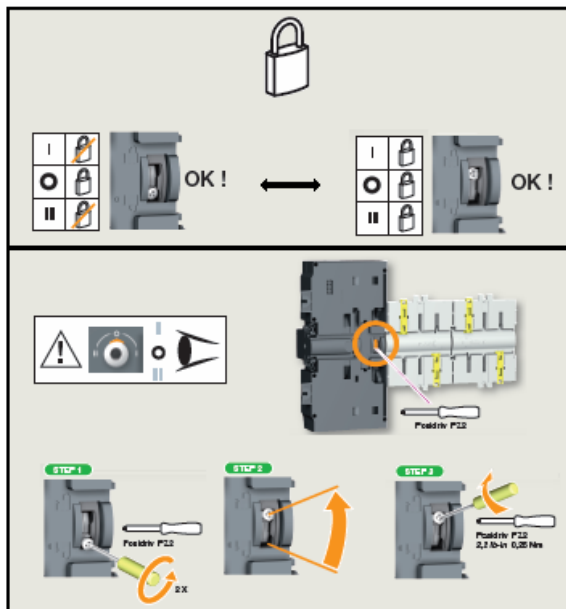

hygrometry :  
 \* 80% humidity without condensation at 5° C  
 \* 95% humidity with condensation at 40° C



altitude :  
 max 2 000 m without de-rating



temperature :  
 \* -10 +40°C without de-rating  
 \* -20 +70°C with de-rating



mass : 5 kg



storage :  
 \* temperature -20 to +70°C  
 \* period : 1 year max

# GenPARTS

## Automatic Transfer Switch V E R S O

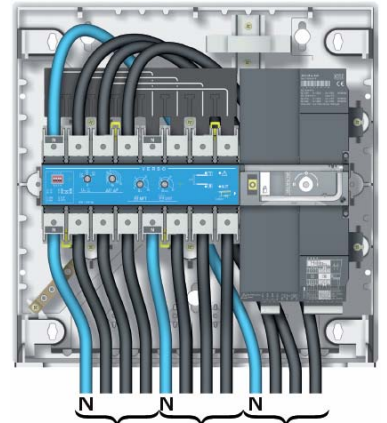
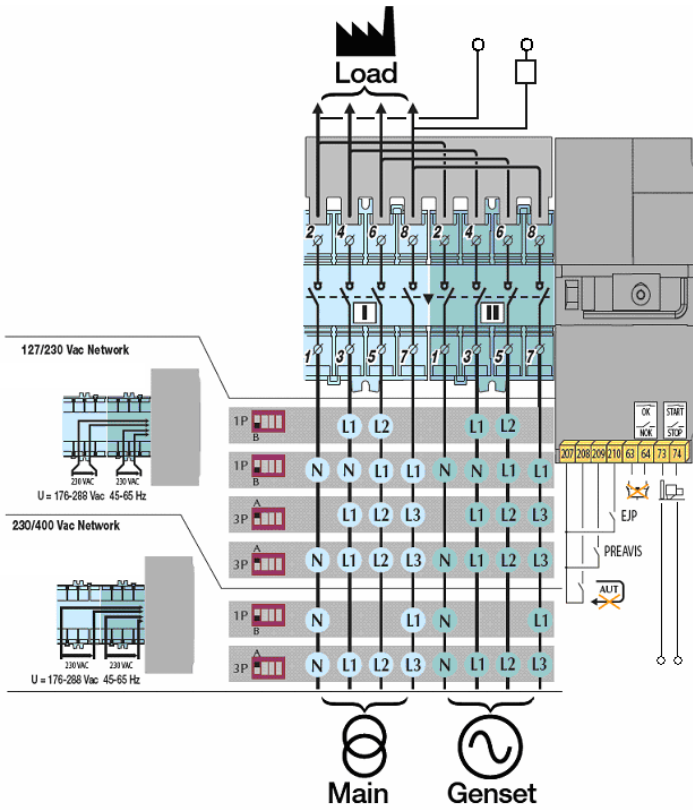

	<b>63 64</b>	<b>73 74</b>
	2A 30Vdc DC1 1A 125Vac AC1 0,5A 230Vac AC1 max 60W or 250VA	2A 30Vdc DC1 1A 125Vac AC1 0,5A 230Vac AC1 max 60W or 250VA
	OK	START
	NOK OR	STOP

**Cables (mm<sup>2</sup>)**

	mini	maxi
35A	16	35
63A	25	50
80A	35	50
100A	35	50
125A	50	70*
160A	50	70*

**Termination:**  
 - 10 to 70 mm<sup>2</sup> # 8 to # 00 AWG  
 - 6 to 50 mm<sup>2</sup> # 10 to # 00 AWG  
 - 15 mm / 0,59"

**Warning:** Hexagonal Metric Allen size 4 44,1 lb-in 5,0 Nm X 8

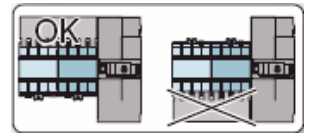

**OPTION**

**Slotted head 3,5mm 3,97 lb-in 0,45Nm**

**Hexagonal Metric Allen size 4 44,1 lb-in 5,0 Nm**

**Slotted head 3mm 3,97 lb-in 0,5Nm**

**Termination:**  
 - 0,5 to 1,5 mm<sup>2</sup> # 20 to # 14 AWG  
 - 0,5 to 1,0 mm<sup>2</sup> # 20 to # 18 AWG  
 - 6 mm / 0,236"

**Termination:**  
 - 10 to 70 mm<sup>2</sup> # 8 to # 00 AWG  
 - 6 to 50 mm<sup>2</sup> # 10 to # 00 AWG  
 - 15 mm / 0,59"

**Termination:**  
 - 0,5 to 2,5 mm<sup>2</sup> # 20 to # 14 AWG  
 - 0,5 to 1,5 mm<sup>2</sup> # 20 to # 18 AWG  
 - 6 mm / 0,236"

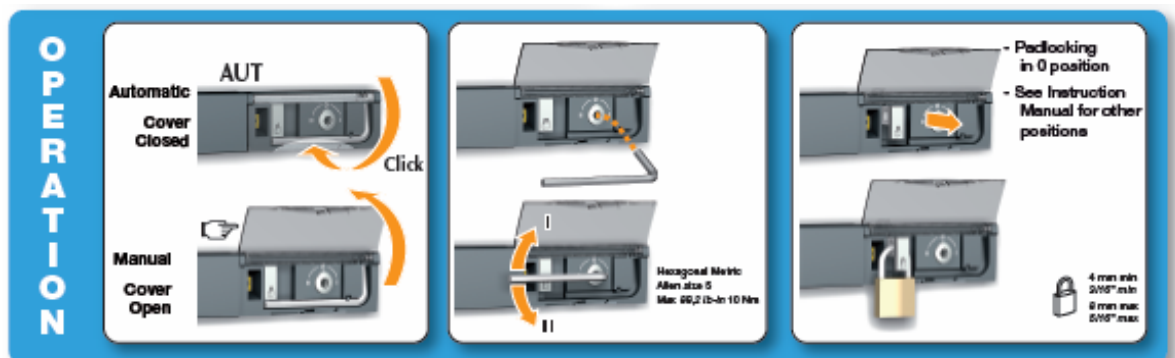
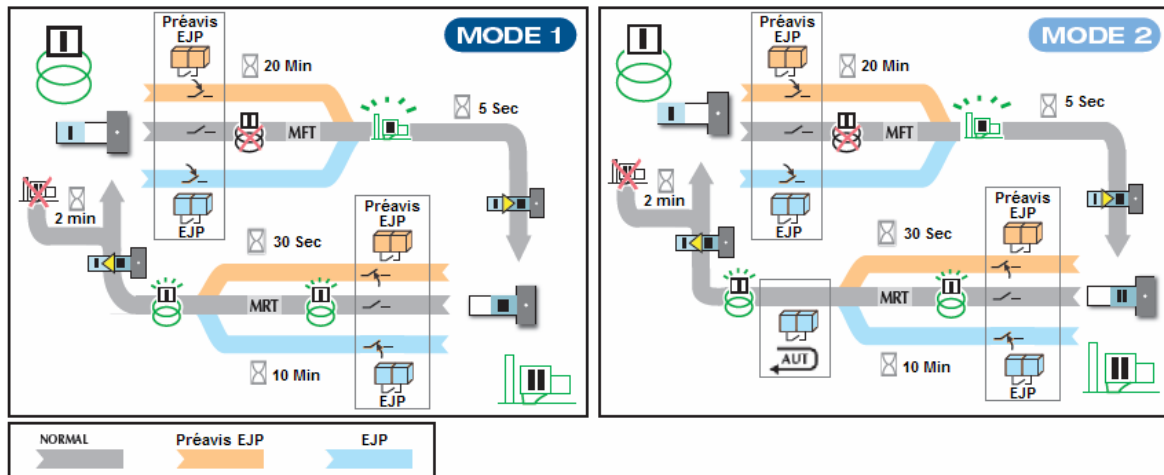
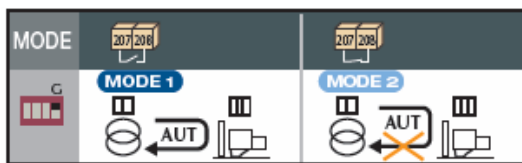
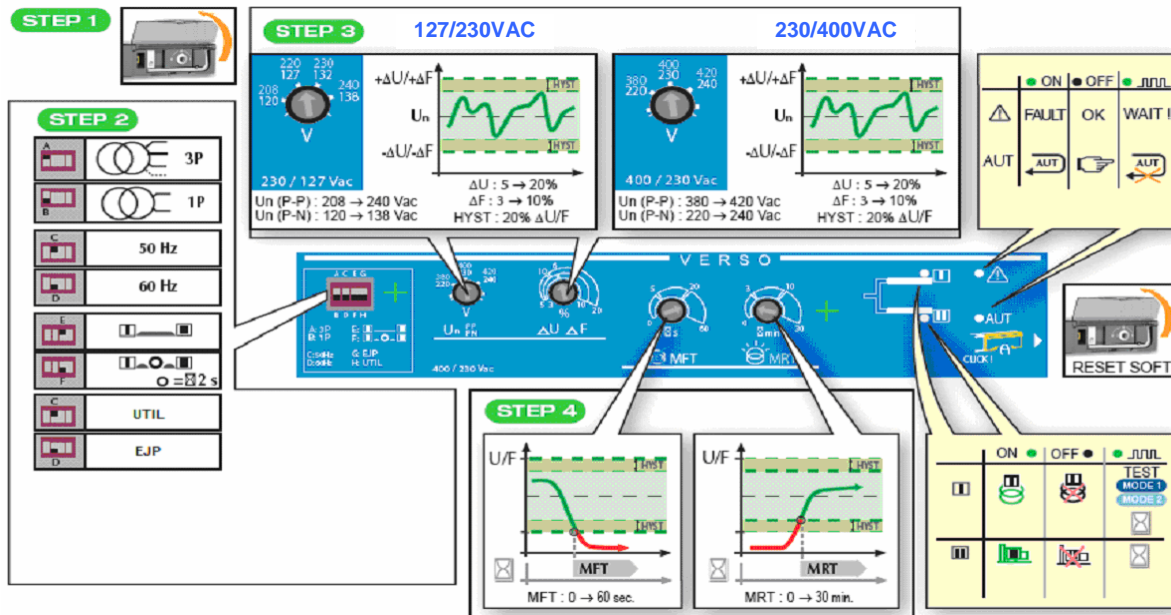

## Options :



Référence :  
31616126101NE



Référence :  
31616126501NE



Référence :  
31616121701NE



Référence :  
31616126601NE



Référence :  
31616126301NE



Référence :  
31616121401NE <= 125A  
31616121501NE > 125A



Référence :  
31616126201NE

## Spare parts:



	127/230 VAC	230/400 VAC
35A	31616120001NE	31616120601NE
63A	31616120101NE	31616120701NE
80A	31616120201NE	31616120801NE
100A	31616120301NE	31616120901NE
125A	31616120401NE	31616121001NE
160A	31616120501NE	31616121101NE

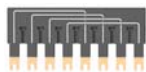

Reference:  
31616121201NE <= 125A  
31616121301NE < 125A



Reference:  
31616126401NE